

GRAIN > STATIONARY AUGERS >  
**U-TROUGH AUGER**

ACCESSORIES

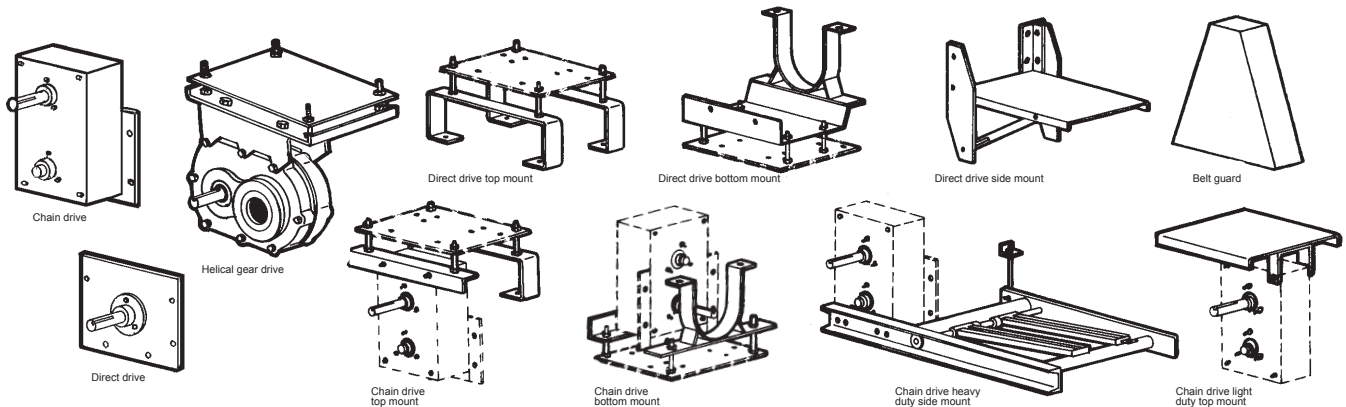

**DRIVES & MOTOR MOUNTS**



**VALVES & ADAPTORS**

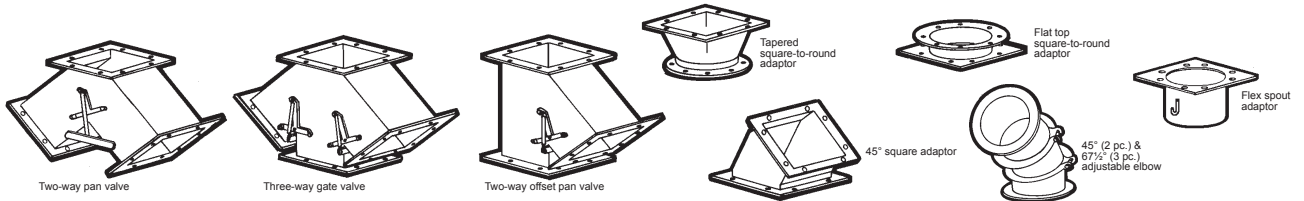

**GUARDED INTAKES**

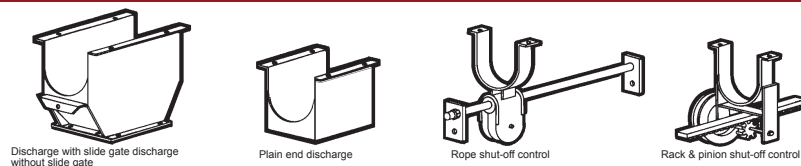

**GUARDED INTAKES**

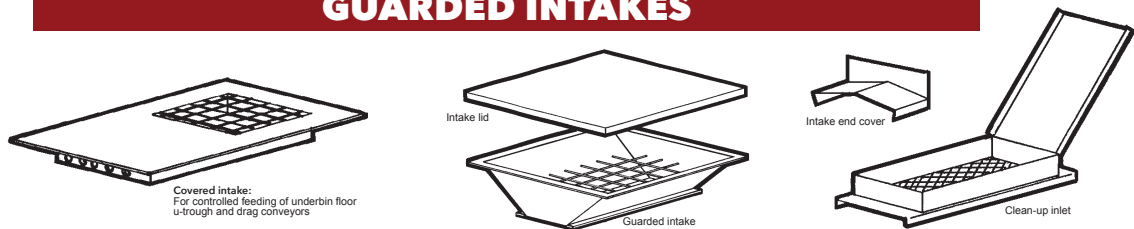

Learn more  
 or get a quote



1-888-SUDENGA | 1-712-475-3301 | Fax: 1-712-475-3320  
 PO Box 8, 2002 Kingbird Ave., George, IA 51237 USA  
 sales@sudenga.com | www.sudenga.com

WWW.SUDENGA.COM

GRAIN > STATIONARY AUGERS >  
**U-TROUGH AUGER**

ACCESSORIES



**SPOUTING**

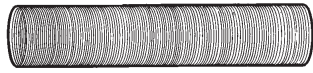

Urethane hose / Galvanized flex hose

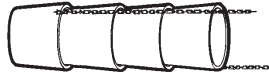

Bucket spout

**REDUCERS**



Square-to-round reducer

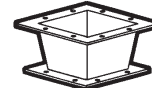

Square-to-square reducer



Two-way reducer

**MOUNTING BRACKETS**

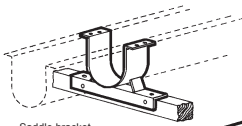

Saddle bracket



Saddle

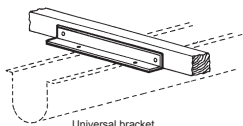

Universal bracket

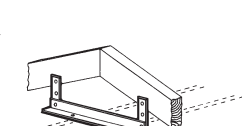

Short hanger bracket

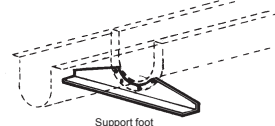

Support foot

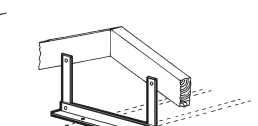

Long hanger bracket

**TRUSSING**



Thimble



Eyebolt



Cable clamp



Truss cable



End truss bracket

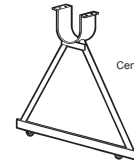

Center truss bracket

**OVER BIN MOUNTING**

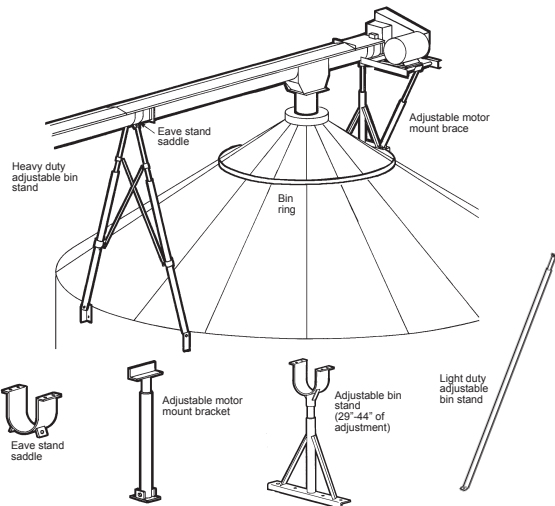

Heavy duty adjustable bin stand

Eave stand saddle

Adjustable motor mount bracket

Adjustable bin stand (23"-44" of adjustment)

Light duty adjustable bin stand

**MISCELLANEOUS**

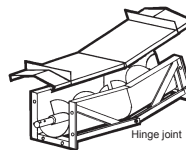

Hinge joint

8 foot screen cleaning section

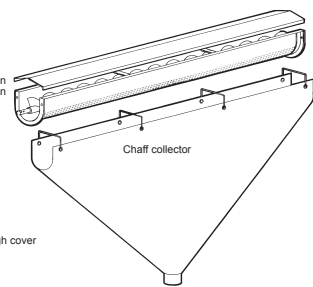

Chaff collector

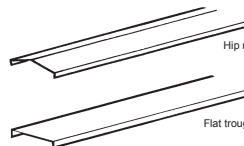

Hip roof trough cover

Flat trough cover



Cast iron holder



End flange



U-trough to round tube adaptor



Hot house pulley



Side pulley

Connect with a Sudenga equipment expert to discuss your upcoming grain handling project needs.

[www.sudenga.com/connect-with-us/](http://www.sudenga.com/connect-with-us/)

Learn more or get a quote



1-888-SUDENGA | 1-712-475-3301 | Fax: 1-712-475-3320  
 PO Box 8, 2002 Kingbird Ave., George, IA 51237 USA  
[sales@sudenga.com](mailto:sales@sudenga.com) | [www.sudenga.com](http://www.sudenga.com)