

GRAIN > STATIONARY AUGERS >
ROUND TUBE AUGER



ACCESSORIES



DRIVES & MOTOR MOUNTS

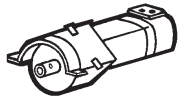

Hydraulic drive
900 and 1000 series
(Motor not included)

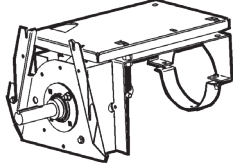

Direct drive
700 and 800 series

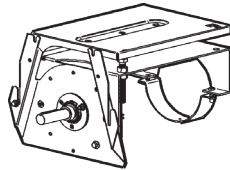

Direct drive
900 and 1000 series

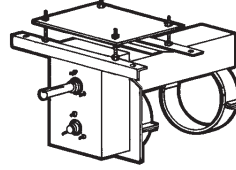

Chain drive
900 and 1000 series

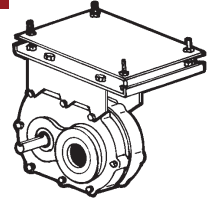

Helical gear drive
700-800-900-1000 series

INTAKE HOPPERS & CAGE INTAKES

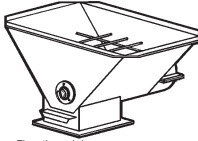

Flow-through hopper

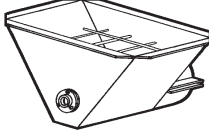

Horizontal hopper

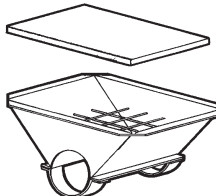

Intermediate hopper
with optional lid

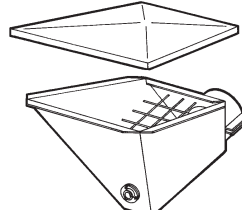

30° inclined hopper
with optional lid

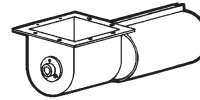

Square end intake-discharge



End plate

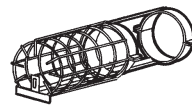

Cage intake plain, with hanger bearing and slide gate

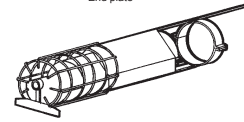

DISCHARGES & SPOUTS



Discharge with or
without slide gate

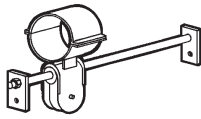

Rope shut-off control

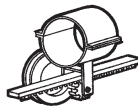

Rack & pinion shut-off control



Square spout 30° and 45°



Round spout 30° and 45°

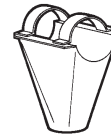

90° round spout

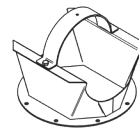

Rounded flanged spout

ADAPTORS

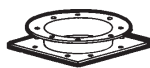

Flat top square-
to-round adaptor



Tapered square-
to-round adaptor



45° square
adaptor



Flex spout
adaptor



Adjustable elbow
45° (2 pc.)
67½° (3 pc.)

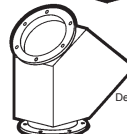

Dead head

WWW.SUDENGA.COM

Learn more
or get a quote



1-888-SUDENGA | 1-712-475-3301 | Fax: 1-712-475-3320
 PO Box 8, 2002 Kingbird Ave., George, IA 51237 USA
 sales@sudenga.com | www.sudenga.com

GRAIN > STATIONARY AUGERS >
ROUND TUBE AUGER

ACCESSORIES



REDUCERS



Square-to-round reducer

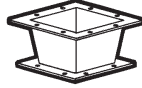

Square-to-square reducer



Two-way reducer

VALVES



Two-way pan valve

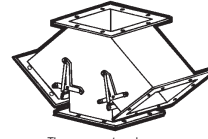

Three-way gate valve

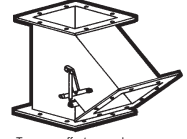

Two-way offset pan valve

SPOUTING & HOSE



Urethane hose / galvanized flex hose

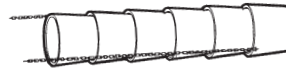

Bucket spout

MOUNTING BRACKETS

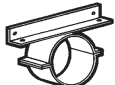

Universal bracket

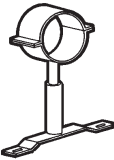

Telescoping bracket



Short frame bracket



Adjustable bracket

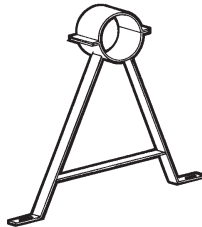

Long frame bracket



Attachment bracket

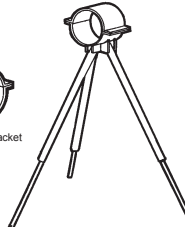

Tripod bracket

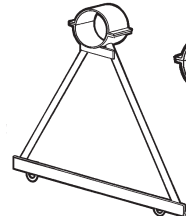

Center truss bracket



End truss bracket



Eyebolt



Thimble



Cable clamp

BIN MOUNTING BRACKETS

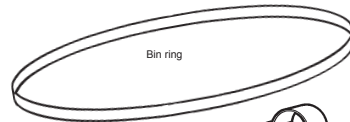
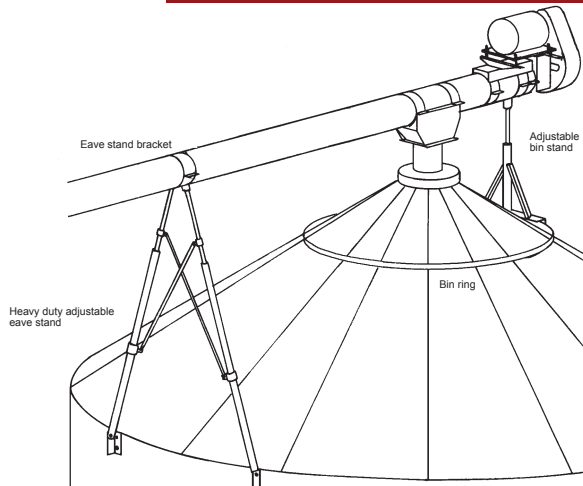

Eave stand bracket

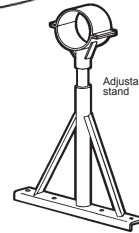

Adjustable bin stand



Light duty adjustable eave stand

Connect with a Sudenga equipment expert to discuss your upcoming grain handling project needs.

www.sudenga.com/connect-with-us/

Learn more or get a quote



1-888-SUDENGA | 1-712-475-3301 | Fax: 1-712-475-3320
 PO Box 8, 2002 Kingbird Ave., George, IA 51237 USA
sales@sudenga.com | www.sudenga.com